

QUAD BUFFER/LINE DRIVER; 3-STATE

FEATURES

- Output capability: bus driver
- I_{CC} category: MSI

GENERAL DESCRIPTION

The 74HC/HCT126 are high-speed Si-gate CMOS devices and are pin compatible with low power Schottky TTL (LSTTL). They are specified in compliance with JEDEC standard no. 7A.

The HC/HCT126 are four non-inverting buffer/line drivers with 3-state outputs. The 3-state outputs (nY) are controlled by the output enable input (nOE). A LOW at nOE causes the outputs to assume a HIGH impedance OFF-state.

The "126" is identical to the "125" but has active HIGH enable inputs.

SYMBOL	PARAMETER	CONDITIONS	TYPICAL		UNIT
			HC	HCT	
t _{PHL} / t _{PLH}	propagation delay nA to nY	C _L = 15 pF V _{CC} = 5 V	9	11	ns
C _I	input capacitance		3.5	3.5	pF
C _{PD}	power dissipation capacitance per buffer	notes 1 and 2	23	24	pF

GND = 0 V; T_{amb} = 25 °C; t_r = t_f = 6 ns

Notes

1. C_{PD} is used to determine the dynamic power dissipation (P_D in μW):

$$P_D = C_{PD} \times V_{CC}^2 \times f_i + \Sigma (C_L \times V_{CC}^2 \times f_o) \text{ where:}$$

f_i = input frequency in MHz C_L = output load capacitance in pF
 f_o = output frequency in MHz V_{CC} = supply voltage in V
 Σ (C_L × V_{CC}² × f_o) = sum of outputs

2. For HC the condition is V_I = GND to V_{CC}
 For HCT the condition is V_I = GND to V_{CC} - 1.5 V

PACKAGE OUTLINES

14-lead DIL; plastic (SOT27)

14-lead mini pack; plastic (SO14; SOT108A)

PIN DESCRIPTION

PIN NO.	SYMBOL	NAME AND FUNCTION
1, 4, 10, 13	1OE to 4OE	output enable inputs (active HIGH)
2, 5, 9, 12	1A to 4A	data inputs
3, 6, 8, 11	1Y to 4Y	data outputs
7	GND	ground (0 V)
14	V _{CC}	positive supply voltage

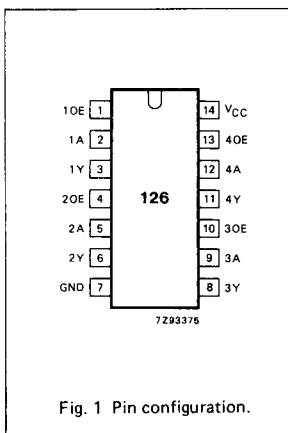

Fig. 1 Pin configuration.

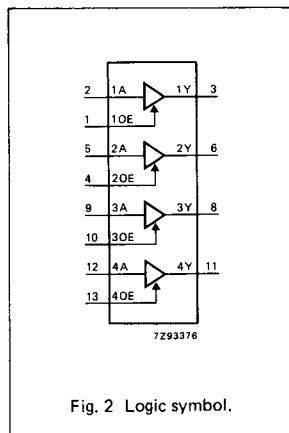

Fig. 2 Logic symbol.

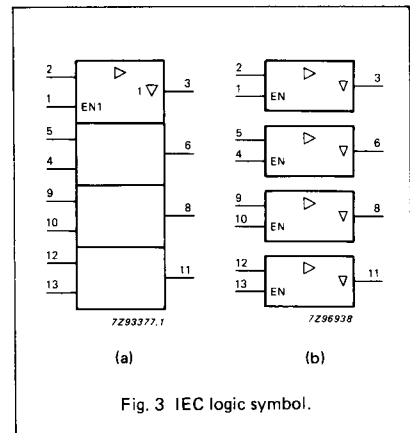

Fig. 3 IEC logic symbol.

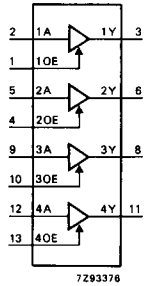

Fig. 4 Functional diagram.

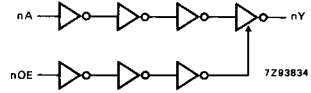

Fig. 5 Logic diagram (one buffer).

FUNCTION TABLE

INPUTS		OUTPUT
nOE	nA	nY
H	L	L
H	H	H
L	X	Z

H = HIGH voltage level
 L = LOW voltage level
 X = don't care
 Z = high impedance OFF-state

DC CHARACTERISTICS FOR 74HC

For the DC characteristics see chapter "HCMOS family characteristics", section "Family specifications".

Output capability: bus driver

I_{CC} category: MSI

AC CHARACTERISTICS FOR 74HC

GND = 0 V; t_r = t_f = 6 ns; C_L = 50 pF

SYMBOL	PARAMETER	T _{amb} (°C)						UNIT	TEST CONDITIONS		
		74HC							V _{CC} V	WAVEFORMS	
		+25			-40 to +85		-40 to +125				
		min.	typ.	max.	min.	max.	min.				max.
t _{PHL} / t _{PLH}	propagation delay nA to nY		30 11 9	100 20 17		125 25 21		150 30 26	ns	2.0 4.5 6.0	Fig. 6
t _{pZH} / t _{pZL}	3-state output enable time nOE to nY		41 15 12	125 25 21		155 31 26		190 38 32	ns	2.0 4.5 6.0	Fig. 7
t _{pHZ} / t _{PLZ}	3-state output disable time nOE to nY		41 15 12	125 25 21		155 31 26		190 38 32	ns	2.0 4.5 6.0	Fig. 7
t _{THL} / t _{TLH}	output transition time		14 5 4	60 12 10		75 15 13		90 18 15	ns	2.0 4.5 6.0	Fig. 6

DC CHARACTERISTICS FOR 74HCT

For the DC characteristics see chapter "HCMOS family characteristics", section "Family specifications".

Output capability: bus driver

I_{CC} category: MSI

Note to HCT types

The value of additional quiescent supply current (ΔI_{CC}) for a unit load of 1 is given in the family specifications. To determine ΔI_{CC} per input, multiply this value by the unit load coefficient shown in the table below.

INPUT	UNIT LOAD COEFFICIENT
nA, nOE	1.00

AC CHARACTERISTICS FOR 74HCT

GND = 0 V; t_r = t_f = 6 ns; C_L = 50 pF

SYMBOL	PARAMETER	T _{amb} (°C)						UNIT	TEST CONDITIONS		
		74HCT							V _{CC} V	WAVEFORMS	
		+25			-40 to +85		-40 to +125				
		min.	typ.	max.	min.	max.	min.				max.
t _{PHL} / t _{PLH}	propagation delay nA to nY		14	24		30		36	ns	4.5	Fig. 6
t _{PZH} / t _{PZL}	3-state output enable time nOE to nY		13	25		31		38	ns	4.5	Fig. 7
t _{PHZ} / t _{PLZ}	3-state output disable time nOE to nY		18	28		35		42	ns	4.5	Fig. 7
t _{THL} / t _{TLH}	output transition time		5	12		15		18	ns	4.5	Fig. 6

AC WAVEFORMS

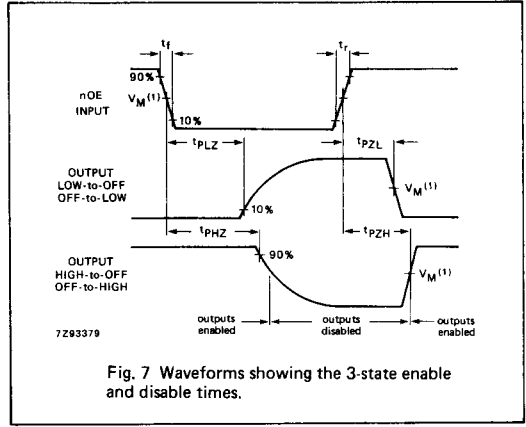
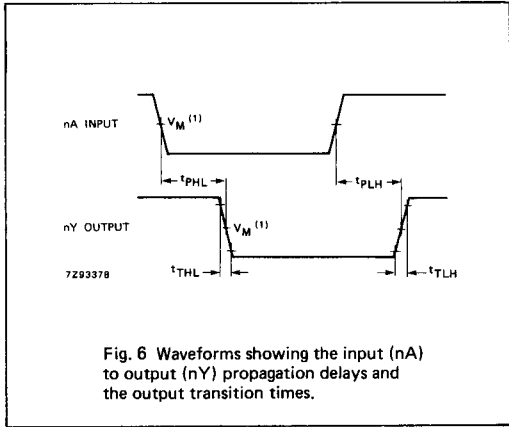

Note to AC waveforms

(1) HC : $V_M = 50\%$; $V_I = \text{GND to } V_{CC}$.
 HCT: $V_M = 1.3 \text{ V}$; $V_I = \text{GND to } 3 \text{ V}$.