

High Speed Optocoupler, 1 MBd, Photodiode with Transistor Output, 110 °C Rated

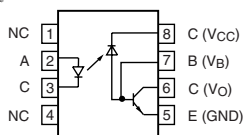
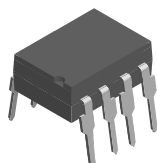

1179081

DESCRIPTION

The 6N1135 and 6N1136 are 110 °C rated optocouplers with a GaAlAs infrared emitting diode, optically coupled with an integrated photo detector which consists of a photo diode and a high-speed transistor in a DIP-8 plastic package.

Signals can be transmitted between two electrically separated circuits up to frequencies of 2.0 MHz. The potential difference between the circuits to be coupled should not exceed the maximum permissible reference voltages.

FEATURES

- Operating temperature from - 55 °C to + 110 °C
- Isolation test voltages: 5300 V_{RMS}
- TTL compatible
- High bit rates: 1.0 MBd
- Bandwidth 2.0 MHz
- Open-collector output
- External base wiring possible
- Lead (Pb)-free component
- Component in accordance to RoHS 2002/95/EC and WEEE 2002/96/EC



RoHS
COMPLIANT

AGENCY APPROVALS

- UL1577, file no. E52744 system code H or J
- DIN EN 60747-5-5
- CUL - file no. E52744, equivalent to CSA bulletin 5A

ORDER INFORMATION

PART	REMARKS
6N1135	CTR ≥ 7 %, DIP-8
6N1136	CTR ≥ 19 %, DIP-8
6N1135-X007	CTR ≥ 7 %, SMD-8 (option 7)
6N1136-X006	CTR ≥ 19 %, DIP-8 400 mil (option 6)
6N1136-X007	CTR ≥ 19 %, SMD-8 (option 7)
6N1136-X009	CTR ≥ 19 %, SMD-8 (option 9)

Note

For additional information on the available options refer to option information.

ABSOLUTE MAXIMUM RATINGS (1)

PARAMETER	TEST CONDITION	SYMBOL	VALUE	UNIT
INPUT				
Reverse voltage		V _R	5.0	V
Forward current		I _F	25	mA
Peak forward current	t = 1.0 ms, duty cycle 50 %	I _{FM}	50	mA
Maximum surge forward current	t ≤ 1.0 μs, 300 pulses/s	I _{FSM}	1.0	A
Thermal resistance		R _{th}	700	K/W
Power dissipation	T _{amb} = 70 °C	P _{diss}	45	mW
OUTPUT				
Supply voltage		V _{CC}	- 0.5 to 15	V
Output voltage		V _O	- 0.5 to 15	V
Emitter base voltage		V _{EBO}	5.0	V
Output current		I _O	8.0	mA
Maximum Output current			16	mA
Base current		I _B	5.0	mA
Thermal resistance			300	K/W
Power dissipation	T _{amb} = 70 °C	P _{diss}	100	mW



High Speed Optocoupler, 1 MBd,
Photodiode with Transistor Output, 110 °C
Rated

Vishay Semiconductors

ABSOLUTE MAXIMUM RATINGS (1)				
PARAMETER	TEST CONDITION	SYMBOL	VALUE	UNIT
COUPLER				
Isolation test voltage (between emitter and detector climate per DIN 50014 part 2, Nov. 74)	t = 1.0 s	V _{ISO}	5300	V _{RMS}
Storage temperature range		T _{stg}	- 55 to + 125	°C
Ambient temperature range		T _{amb}	- 55 to + 100	°C
Soldering temperature (2)	max. ≤ 10 s, dip soldering ≥ 0.5 mm from case bottom	T _{sld}	260	°C

Notes(1) T_{amb} = 25 °C, unless otherwise specified.

Stresses in excess of the absolute maximum ratings can cause permanent damage to the device. Functional operation of the device is not implied at these or any other conditions in excess of those given in the operational sections of this document. Exposure to absolute maximum ratings for extended periods of the time can adversely affect reliability.

(2) Refer to reflow profile for soldering conditions for surface mounted devices (SMD). Refer to wave profile for soldering conditions for through hole devices (DIP).

ELECTRICAL CHARACTERISTICS							
PARAMETER	TEST CONDITION	PART	SYMBOL	MIN.	TYP.	MAX.	UNIT
INPUT							
Forward voltage	I _F = 1.6 mA		V _F		1.6	1.9	V
Breakdown voltage	I _R = 10 μA		V _{BR}	5.0			V
Reverse current	V _R = 5.0 V		I _R		0.5	10	μA
Capacitance	V _R = 0 V, f = 1.0 MHz		C _I		125		pF
Temperature coefficient, forward voltage	I _F = 1.6 mA		ΔV _F /ΔT _A		- 1.7		mV/°C
OUTPUT							
Logic low supply current	I _F = 1.6 mA, V _O = open, V _{CC} = 15 V		I _{CCL}		150		μA
Logic high supply current	I _F = 0 mA, V _O = open, V _{CC} = 15 V		I _{CCH}		0.01	1	μA
Output voltage, output low	I _F = 16 mA, V _{CC} = 4.5 V, I _O = 1.1 mA,	6N1135	V _{OL}		0.1	0.4	V
	I _F = 16 mA, V _{CC} = 4.5 V, I _O = 2.4 mA,	6N1136	V _{OL}		0.1	0.4	V
Output current, output high	I _F = 0 mA, V _O = V _{CC} = 5.5 V		I _{OH}		3.0	500	nA
	I _F = 0 mA, V _O = V _{CC} = 15 V		I _{OH}		0.01	1	μA
COUPLER							
Capacitance (input to output)	f = 1.0 MHz		C _{IO}		0.6		pF
Current transfer ratio	I _F = 16 mA, V _O = 0.4 V, V _{CC} = 4.5 V	6N1135	CTR	7.0	16		%
		6N1136	CTR	19	35		%
	I _F = 16 mA, V _O = 0.5 V, V _{CC} = 4.5 V	6N1135	CTR	5.0			%
		6N1136	CTR	15			%

NoteT_{amb} = 25 °C, unless otherwise specified.

Minimum and maximum values are testing requirements. Typical values are characteristics of the device and are the result of engineering evaluation. Typical values are for information only and are not part of the testing requirements.

SWITCHING CHARACTERISTICS							
PARAMETER	TEST CONDITION	PART	SYMBOL	MIN.	TYP.	MAX.	UNIT
High to low	$I_F = 16 \text{ mA}, V_{CC} = 5.0 \text{ V}, R_L = 4.1 \text{ k}\Omega$	6N1135	t_{PHL}		0.3	1.5	μs
	$I_F = 16 \text{ mA}, V_{CC} = 5.0 \text{ V}, R_L = 1.9 \text{ k}\Omega$	6N1136	t_{PHL}		0.2	0.8	μs
Low to high	$I_F = 16 \text{ mA}, V_{CC} = 5.0 \text{ V}, R_L = 4.1 \text{ k}\Omega$	6N1135	t_{PLH}		0.3	1.5	μs
	$I_F = 16 \text{ mA}, V_{CC} = 5.0 \text{ V}, R_L = 1.9 \text{ k}\Omega$	6N1136	t_{PLH}		0.2	0.8	μs

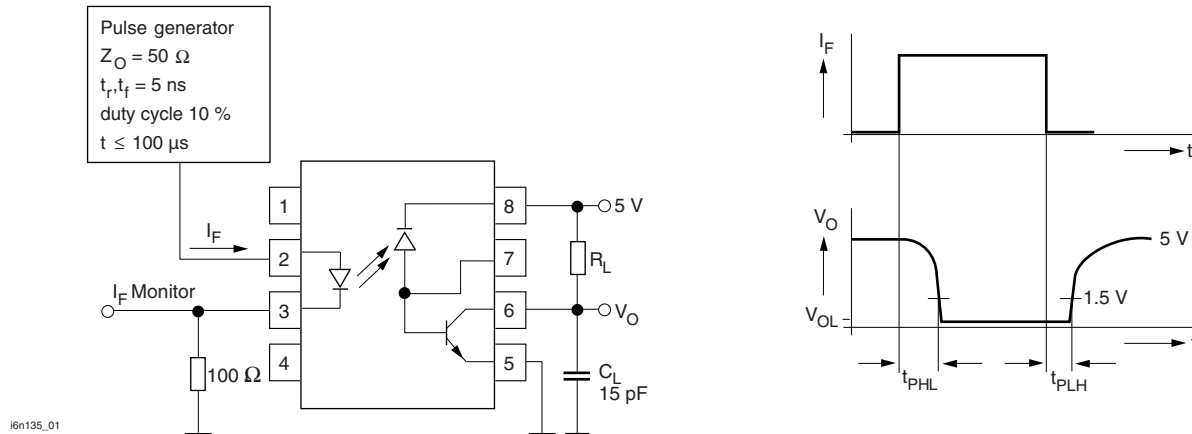

Fig. 1 - Switching Times

COMMON MODE TRANSIENT IMMUNITY							
PARAMETER	TEST CONDITION	PART	SYMBOL	MIN.	TYP.	MAX.	UNIT
High	$I_F = 0 \text{ mA}, V_{CM} = 10 \text{ V}_{P-P}, V_{CC} = 5.0 \text{ V}, R_L = 4.1 \text{ k}\Omega$	6N1135	$ CM_H $		1000		$\text{V}/\mu\text{s}$
	$I_F = 0 \text{ mA}, V_{CM} = 10 \text{ V}_{P-P}, V_{CC} = 5.0 \text{ V}, R_L = 1.9 \text{ k}\Omega$	6N1136	$ CM_H $		1000		$\text{V}/\mu\text{s}$
Low	$I_F = 16 \text{ mA}, V_{CM} = 10 \text{ V}_{P-P}, V_{CC} = 5.0 \text{ V}, R_L = 4.1 \text{ k}\Omega$	6N1135	$ CM_L $		1000		$\text{V}/\mu\text{s}$
	$I_F = 16 \text{ mA}, V_{CM} = 10 \text{ V}_{P-P}, V_{CC} = 5.0 \text{ V}, R_L = 1.9 \text{ k}\Omega$	6N1136	$ CM_L $		1000		$\text{V}/\mu\text{s}$

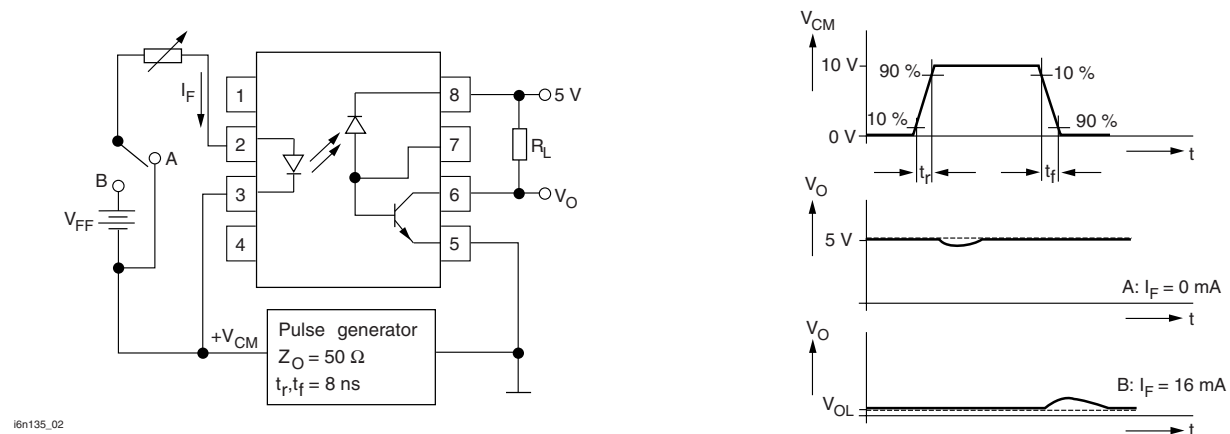

Fig. 2 - Common-Mode Interference Immunity



High Speed Optocoupler, 1 MBd, Vishay Semiconductors
 Photodiode with Transistor Output, 110 °C
 Rated

SAFETY AND INSULATION RATINGS						
PARAMETER	TEST CONDITION	SYMBOL	MIN.	TYP.	MAX.	UNIT
Climatic classification (according to IEC 68 part 1)				55/110/21		
Pollution degree (DIN VDE 0109)				2.0		
Comparative tracking index per DIN IEC112/VDE 0303 part 1, group IIIa per DIN VDE 6110		CTI	175		399	
V_{IOTM}		V_{IOTM}	8000			V
V_{IORM}		V_{IORM}	630			V
Isolation resistance	$V_{IO} = 500\text{ V}, T_{amb} = 25\text{ °C}$	R_{IO}	10^{12}			Ω
	$V_{IO} = 500\text{ V}, T_{amb} = 100\text{ °C}$	R_{IO}	10^{11}			Ω
P_{SI}		P_{SI}			500	mA
I_{SI}		I_{SI}			300	mW
T_{SI}		T_{SI}			175	°C
Creepage distance			7.0			mm
Clearance distance			7.0			mm
Insulation thickness			0.2			mm

Note

As per IEC 60747-5-2, § 7.4.3.8.1, this optocoupler is suitable for “safe electrical insulation” only within the safety ratings. Compliance with the safety ratings shall be ensured by means of protective circuits.

TYPICAL CHARACTERISTICS

$T_{amb} = 25\text{ °C}$, unless otherwise specified

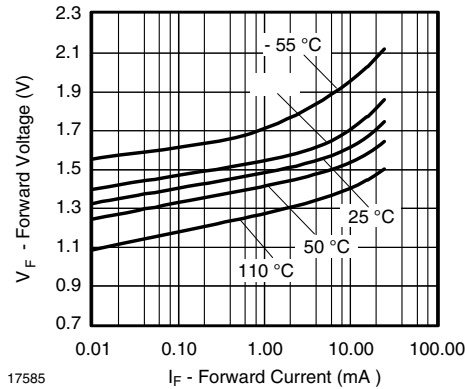

Fig. 3 - Forward Voltage vs. Forward Current

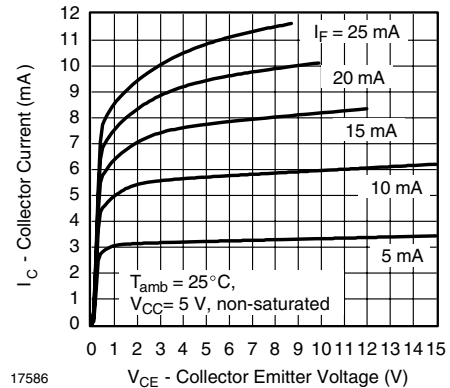

Fig. 4 - Collector Current vs. Collector Emitter Voltage

Vishay Semiconductors High Speed Optocoupler, 1 MBd,
Photodiode with Transistor Output, 110 °C
Rated

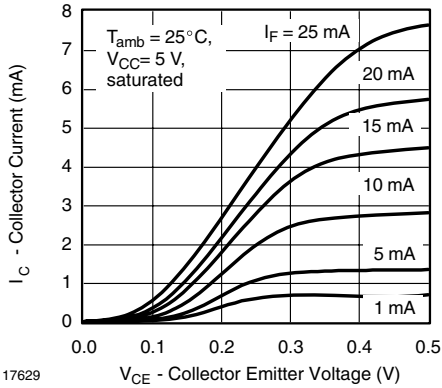

Fig. 5 - Collector Current vs. Collector Emitter Voltage

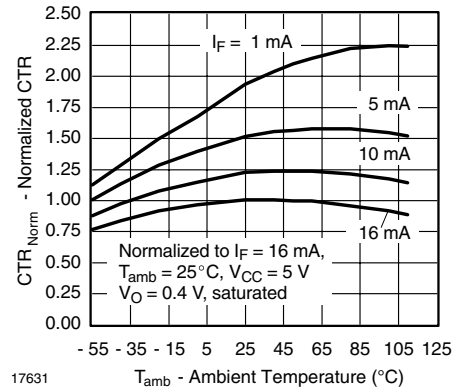

Fig. 8 - Normalized Current Transfer Ratio vs. Ambient Temperature

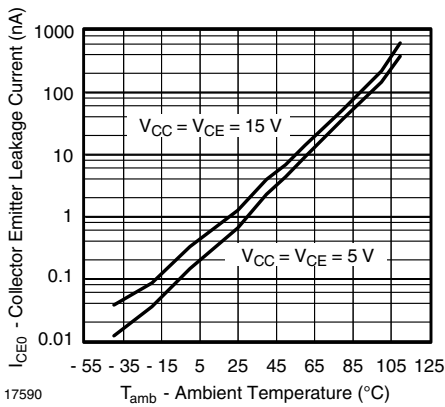

Fig. 6 - Collector Emitter Dark Current vs. Ambient Temperature

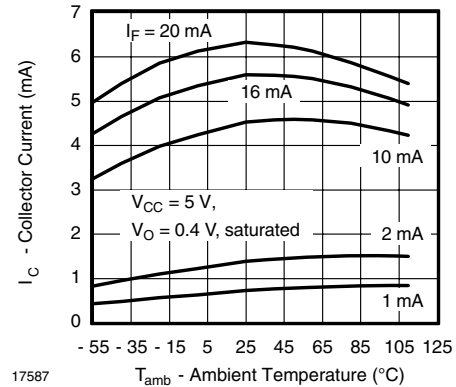

Fig. 9 - Output Current vs. Temperature

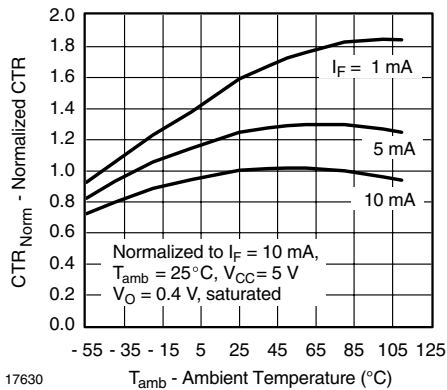

Fig. 7 - Normalized Current Transfer Ratio vs. Ambient Temperature

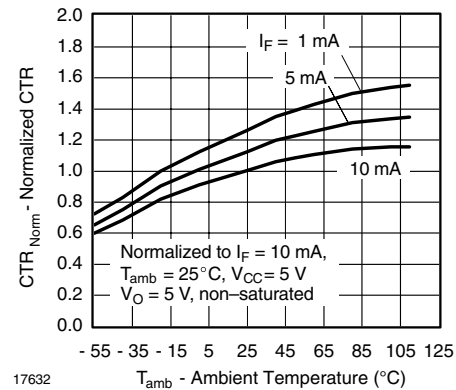

Fig. 10 - Normalized Current Transfer Ratio vs. Ambient Temperature



High Speed Optocoupler, 1 MBd, Vishay Semiconductors
 Photodiode with Transistor Output, 110 °C
 Rated

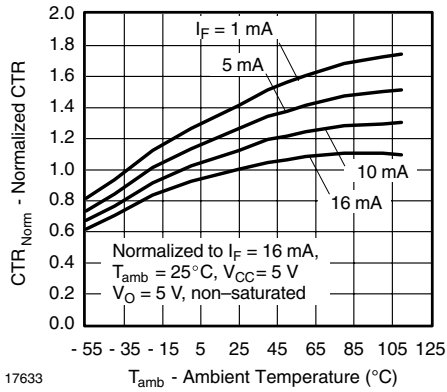

Fig. 11 - Normalized Current Transfer Ratio vs. Ambient Temperature

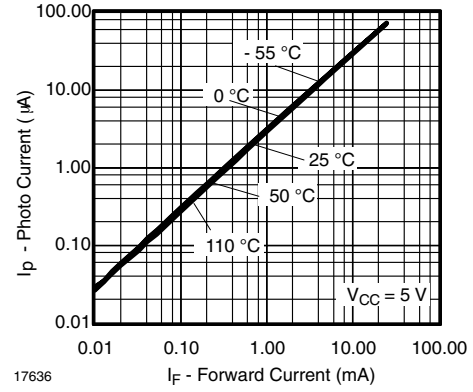

Fig. 14 - Photo Current vs. Forward Current

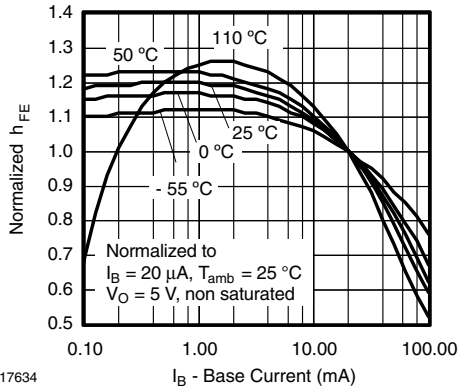

Fig. 12 - Normalized h_{FE} vs. Base Current

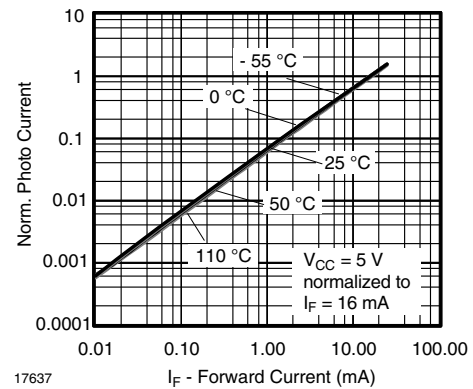

Fig. 15 - Photo Current vs. Forward Current

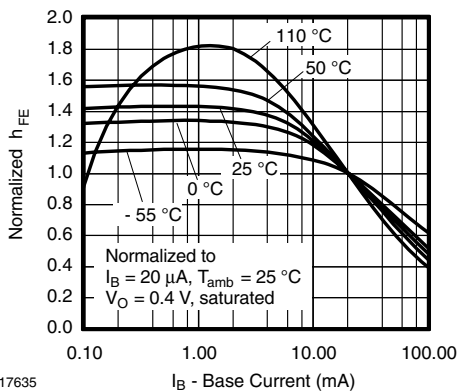

Fig. 13 - Normalized h_{FE} vs. Base Current

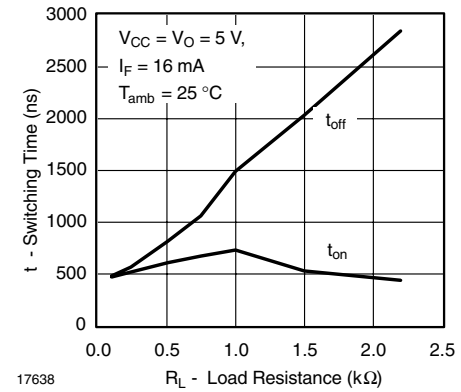

Fig. 16 - Switching Time vs. Load Resistance

Vishay Semiconductors High Speed Optocoupler, 1 MBd,
Photodiode with Transistor Output, 110 °C
Rated

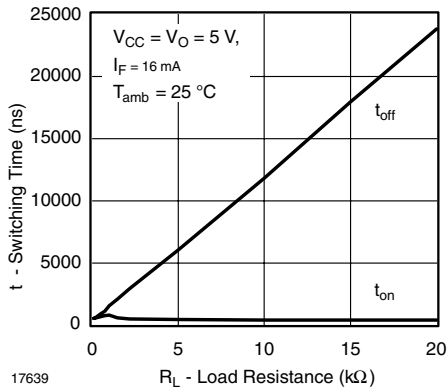

Fig. 17 - Switching Time vs. Load Resistance

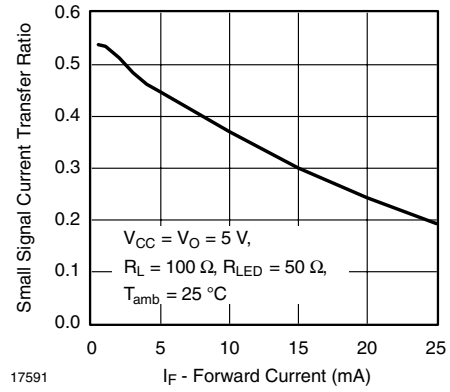

Fig. 20 - Small Signal CTR vs. Forward Current

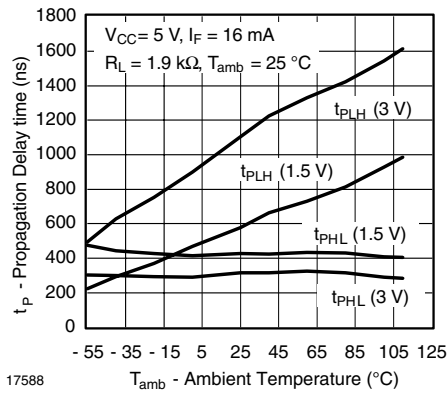

Fig. 18 - Propagation Delay vs. Ambient Temperature

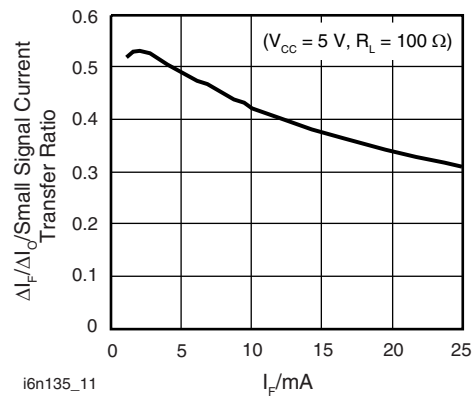

Fig. 21 - Small Signal Current Transfer Ratio vs. Quiescent Input Current

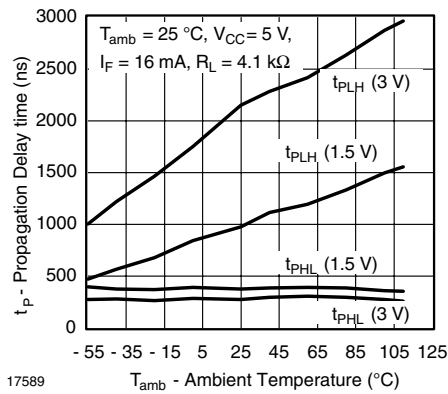
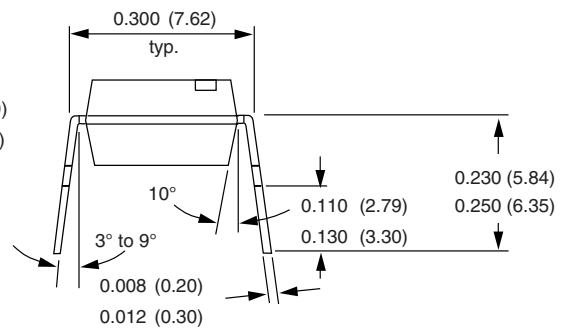
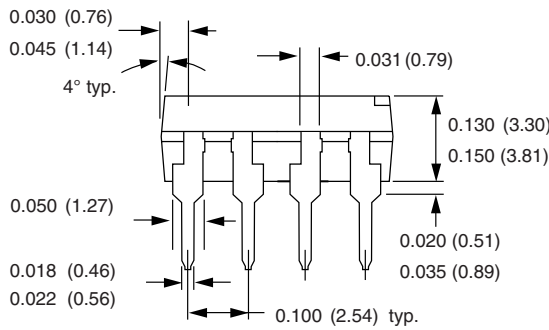
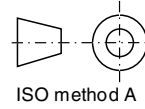
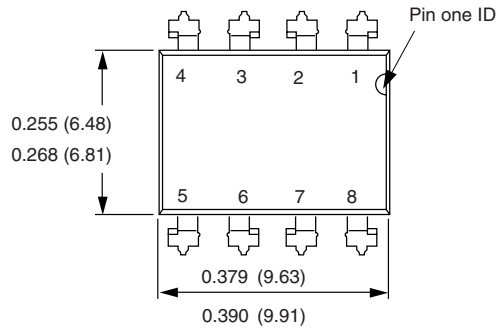

Fig. 19 - Propagation Delay vs. Ambient Temperature



High Speed Optocoupler, 1 MBd, Vishay Semiconductors
Photodiode with Transistor Output, 110 °C
Rated

PACKAGE DIMENSIONS in inches (millimeters)



i178006

Option 6

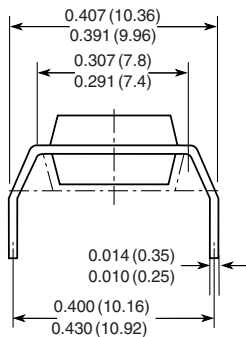

Option 7

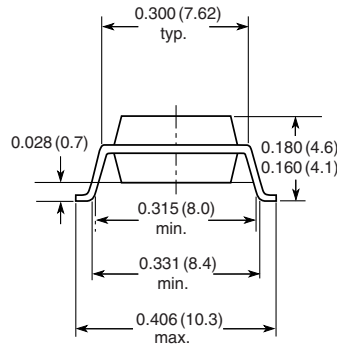

Option 9

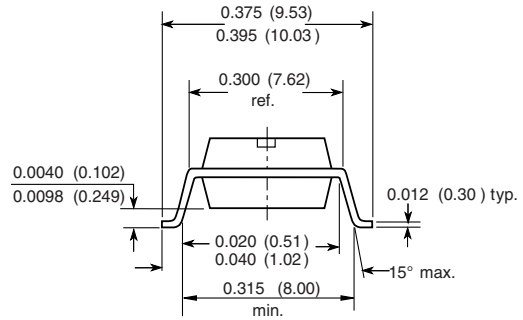

18450



High Speed Optocoupler, 1 MBd,
Photodiode with Transistor Output, 110 °C
Rated

Vishay Semiconductors

OZONE DEPLETING SUBSTANCES POLICY STATEMENT

It is the policy of Vishay Semiconductor GmbH to

1. Meet all present and future national and international statutory requirements.
2. Regularly and continuously improve the performance of our products, processes, distribution and operating systems with respect to their impact on the health and safety of our employees and the public, as well as their impact on the environment.

It is particular concern to control or eliminate releases of those substances into the atmosphere which are known as ozone depleting substances (ODSs).

The Montreal Protocol (1987) and its London Amendments (1990) intend to severely restrict the use of ODSs and forbid their use within the next ten years. Various national and international initiatives are pressing for an earlier ban on these substances.

Vishay Semiconductor GmbH has been able to use its policy of continuous improvements to eliminate the use of ODSs listed in the following documents.

1. Annex A, B and list of transitional substances of the Montreal Protocol and the London Amendments respectively.
2. Class I and II ozone depleting substances in the Clean Air Act Amendments of 1990 by the Environmental Protection Agency (EPA) in the USA.
3. Council Decision 88/540/EEC and 91/690/EEC Annex A, B and C (transitional substances) respectively.

Vishay Semiconductor GmbH can certify that our semiconductors are not manufactured with ozone depleting substances and do not contain such substances.

We reserve the right to make changes to improve technical design
and may do so without further notice.

Parameters can vary in different applications. All operating parameters must be validated for each customer application by the customer. Should the buyer use Vishay Semiconductors products for any unintended or unauthorized application, the buyer shall indemnify Vishay Semiconductors against all claims, costs, damages, and expenses, arising out of, directly or indirectly, any claim of personal damage, injury or death associated with such unintended or unauthorized use.

Vishay Semiconductor GmbH, P.O.B. 3535, D-74025 Heilbronn, Germany



Disclaimer

All product specifications and data are subject to change without notice.

Vishay Intertechnology, Inc., its affiliates, agents, and employees, and all persons acting on its or their behalf (collectively, "Vishay"), disclaim any and all liability for any errors, inaccuracies or incompleteness contained herein or in any other disclosure relating to any product.

Vishay disclaims any and all liability arising out of the use or application of any product described herein or of any information provided herein to the maximum extent permitted by law. The product specifications do not expand or otherwise modify Vishay's terms and conditions of purchase, including but not limited to the warranty expressed therein, which apply to these products.

No license, express or implied, by estoppel or otherwise, to any intellectual property rights is granted by this document or by any conduct of Vishay.

The products shown herein are not designed for use in medical, life-saving, or life-sustaining applications unless otherwise expressly indicated. Customers using or selling Vishay products not expressly indicated for use in such applications do so entirely at their own risk and agree to fully indemnify Vishay for any damages arising or resulting from such use or sale. Please contact authorized Vishay personnel to obtain written terms and conditions regarding products designed for such applications.

Product names and markings noted herein may be trademarks of their respective owners.